

AT SERIES INDUCTIVE PROXIMITY SENSORS

Specifications	Standard Distance Models		Extended Distance Models	
Type	Shielded	Unshielded	Shielded	Unshielded
Material Correction Factors	*See Material Influence table #1			
Differential Travel	2 to 10%		2 to 15%	
Repeat Accuracy	3 wire: 2% / 2 wire: 5%		2 and 3 wire: 5%	
Operating Voltage	10-30VDC			
Ripple	≤10%			
Load Current	3 wire: ≤400mA / 2 wire: 3-100mA		2 and 3 wire: ≤400mA	
Leakage Current	3 wire: ≤10µA / 2 wire: ≤0.8mA max.		3 wire ≤8µA / 2 wire: ≤0.8mA max.	
Voltage Drop	3 wire: ≤1 volt max. / 2 wire: ≤2.8V		3 wire: ≤1 volt max. / 2 wire: ≤2.8V	
Output Type	Three wire: NPN or PNP/N.O. (normally open) / Two wire: sink/source, N.O. only			
Switching Frequency	3 wire: 200Hz / 2 wire: 150Hz		2 and 3 wire: 150Hz	
(tv) Time Delay Before Availability	3 wire: 100ms / 2 wire: 50ms		3 wire: 100ms / 2 wire: 50ms	
Input Voltage Transients Protection	Yes, as long as the transient peak does not exceed 30VDC			
Input Power Polarity Reversal Protection	Yes			
Output Power Short-Circuit Protection	Yes (switch autoresets after overload is removed)			
Temperature Range	-25° to + 70° C (-13° to 158° F)			
Temperature Drift	10% Sr			
Protection Degree (DIN 40050)	IEC IP67			
LED Indicators	Yellow (N.O. output energized)			
Housing Material	Nickel-plated brass			
Sensing Face Material	PBT			
Tightening Torque	60Nm (44lbs./ft.)			
Weight	A type (w/ cable): 180g (6.35oz) H type: 110g (3.88oz)			

*See Material Influence table #1 on page 17-53

Wiring diagrams

Diagram 1

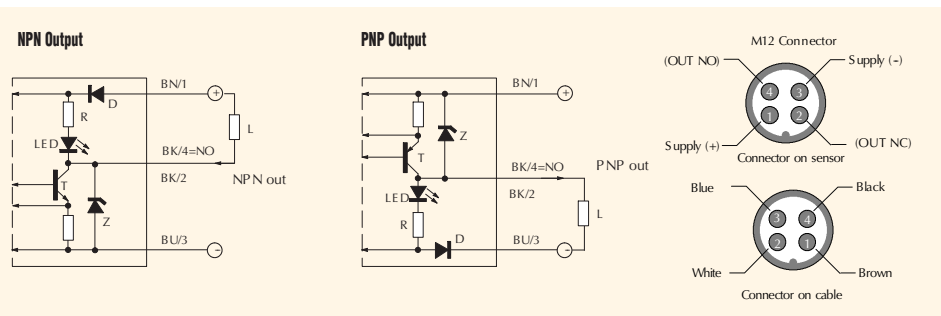
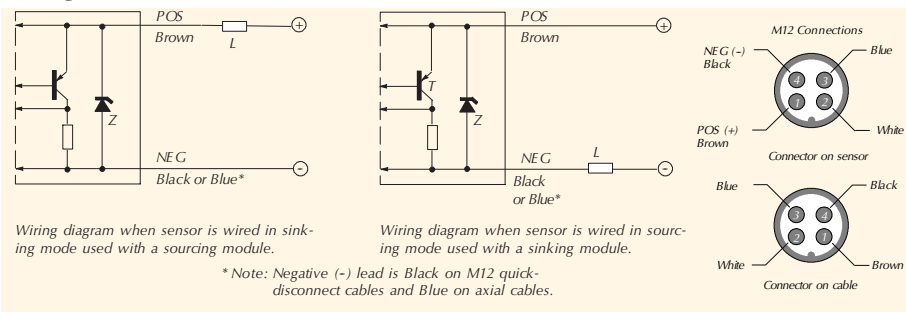

Diagram 2



PROXIMITY SENSORS ACCESSORIES: CABLES

Cables with quick-disconnect plugs



- Industry standard M8 and M12 screw-lock connectors
- Axial cable and right-angle connector models available
- Available in 2m, 5m, and 7m cable lengths
- PVC (polyvinyl chloride) jacket available for typical industrial applications
- PUR (polyurethane) jacket available for oily and direct sunlight applications
- IP67 rated

Dimensions

Figure 1

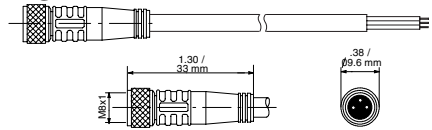

Figure 2

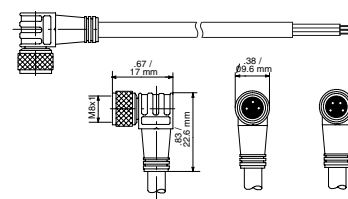

Figure 3

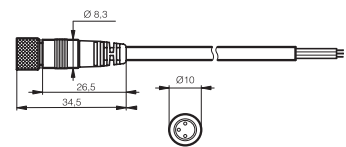

Figure 4

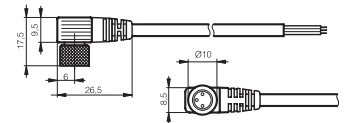

Figure 5

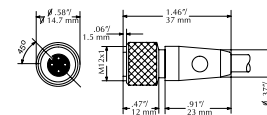
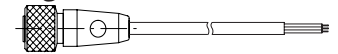

Figure 6

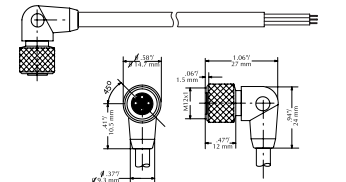

Figure 7

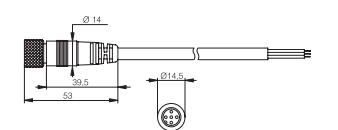
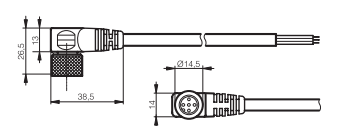

Figure 8



M8 Quick-Disconnect Cables						
Part Number	Price	Length	Poles	Connector	Jacket	Dimensions
M8 Quick-Disconnects						
CD08-0A-020-A1	<--->	2m (6.5ft.)	3	Axial	PVC	Figure 1
CD08-0A-020-C1	<--->	2m (6.5ft.)	3	Right-angle	PVC	Figure 2
CD08-0A-050-A1	<--->	5m (16.4ft.)	3	Axial	PVC	Figure 3
CD08-0C-050-A1	<--->	5m (16.4ft.)	3	Axial	PUR	Figure 3
CD08-0A-050-C1	<--->	5m (16.4ft.)	3	Right-angle	PVC	Figure 4
CD08-0C-050-C1	<--->	5m (16.4ft.)	3	Right-angle	PUR	Figure 4
CD08-0A-070-A1	<--->	7m (23ft.)	3	Axial	PVC	Figure 1
CD08-0A-070-C1	<--->	7m (23ft.)	3	Right-angle	PVC	Figure 2

M12 Quick-Disconnect Cables						
Part Number	Price	Length	Poles	Connector	Jacket	Dimensions
M12 Quick-Disconnects						
CD12L-0B-020-A0	<--->	2m (6.5ft.)	4	Axial	PVC	Figure 5
CD12L-0B-020-C0	<--->	2m (6.5ft.)	4	Right-angle	PVC	Figure 6
CD12M-0B-050-A1*	<--->	5m (16.4ft.)	3	Axial	PVC	Figure 7
CD12M-0D-050-A1*	<--->	5m (16.4ft.)	3	Axial	PUR	Figure 7
CD12M-0B-050-C1*	<--->	5m (16.4ft.)	3	Right-angle	PVC	Figure 8
CD12M-0D-050-C1*	<--->	5m (16.4ft.)	3	Right-angle	PUR	Figure 8
CD12M-0B-070-A1	<--->	7m (23ft.)	4	Axial	PVC	Figure 5
CD12M-0B-070-C1	<--->	7m (23ft.)	4	Right-angle	PVC	Figure 5

* Note: Do not use with SU and TU series.

Cable Specifications	M8		M12	
Length	2m (6.5ft.)/ 7m (23ft.)	5m (16.4ft.)	2m (6.5ft.)/ 7m (23ft.)	5m (16.4ft.)
Nominal Voltage	50VAC/75VDC	60VAC/75VDC	300VAC	60VAC/75VDC
Nominal Current	4A	1.5A	4A	1.5A
Protection Degree	IEC IP67		IEC IP67	
Contact Body Material	ABS	PUR	ABS	PUR
Housing Material	PUR		PUR	
Contacts Material	CuSn	CuZn	CuSn	CuZn
Conductors Section	0.34mm ²		0.34mm ²	
Ø Outer Cable	5mm		5mm	
Temperature Range	-25° to +70°C (-13° to 158°F)		-25° to +70°C (-13° to 158°F)	

PROXIMITY SENSORS ACCESSORIES: EXTENSION CABLES



Extension cables with quick-disconnect plugs on each end

Available extension cables include:

- Industry standard M8 and M12 screw-lock connectors
- Axial and right-angle connector models
- 1m and 3m cable lengths
- PVC (polyvinyl chloride) jacket for typical industrial applications
- IP67 rated

Dimensions

Figure 1

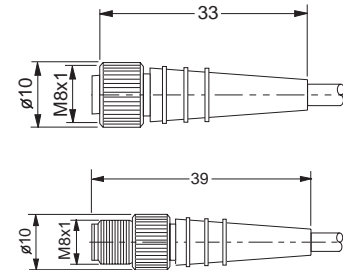

Figure 2

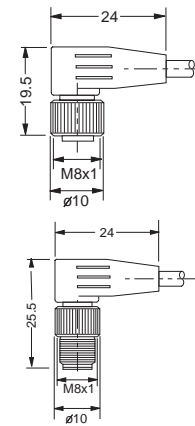

Figure 3

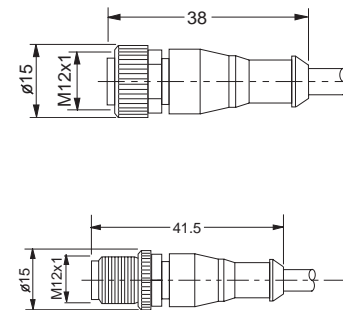
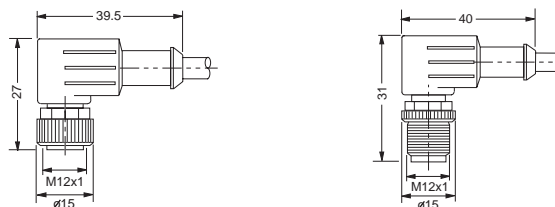

Figure 4



M8 Extension Cables with Quick-Disconnect on each end						
Part Number	Price	Length	Poles	Connectors	Jacket	Dimensions
M8 Quick-Disconnect Extension Cables						
CDP08-0A-010-AA	<--->	1m (3.28ft.)	3	2 Axial	PVC	Figure 1
CDP08-0A-010-BB	<--->	1m (3.28ft.)	3	2 Right-angle	PVC	Figure 2
CDP08-0A-030-AA	<--->	3m (9.84ft.)	3	2 Axial	PVC	Figure 1
CDP08-0A-030-BB	<--->	3m (9.84ft.)	3	2 Right-angle	PVC	Figure 2

M12 Extension Cables with Quick-Disconnect on each end						
Part Number	Price	Length	Poles	Connectors	Jacket	Dimensions
M12 Quick-disconnect Extension Cables						
CDP12-0B-010-AA	<--->	1m (3.28ft.)	4	2 Axial	PVC	Figure 3
CDP12-0B-010-BB	<--->	1m (3.28ft.)	4	2 Right-angle	PVC	Figure 4
CDP12-0B-030-AA	<--->	3m (9.84ft.)	4	2 Axial	PVC	Figure 3
CDP12-0B-030-BB	<--->	3m (9.84ft.)	4	2 Right-angle	PVC	Figure 4

Cable Specifications	M8 / M12
Length	1m (3.28ft.)/ 3m (9.84ft.)
Nominal Voltage	50VAC/75VDC
Nominal Current	4A
Protection Degree	IEC IP67
Contact Body Material	ABS
Housing Material	PUR
Contacts Material	CuSn
Conductors Section	0.34mm ²
Ø Outer Cable	5mm
Temperature Range	-25° to +70°C (-13° to 158°F)